

Equipamentos

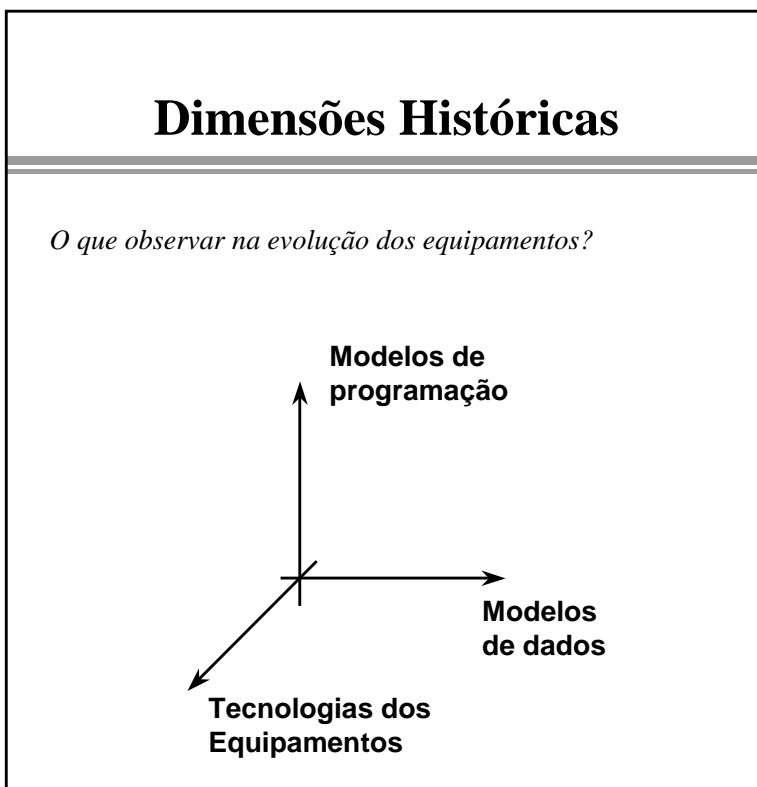

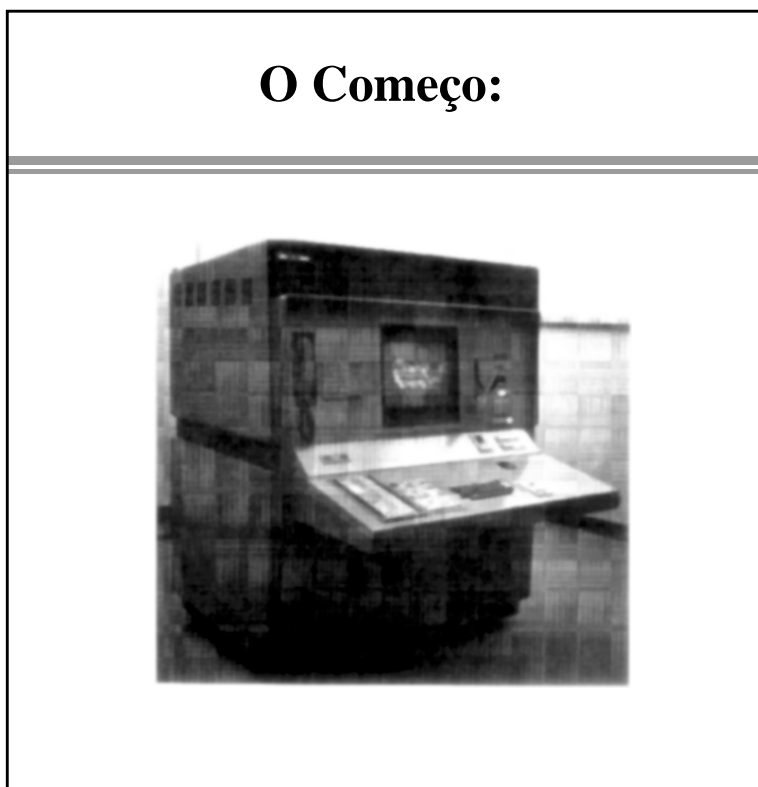

A Base: Tubo de Raios Catódicos

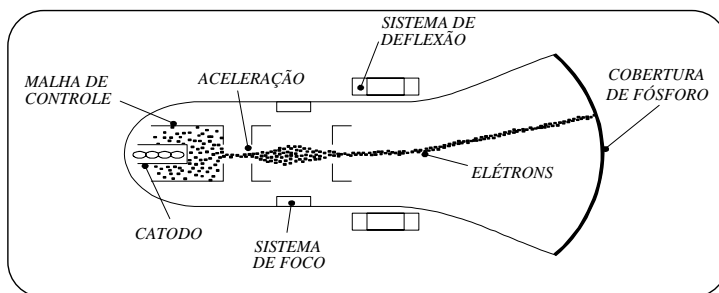

O Elemento Gráfico Nativo

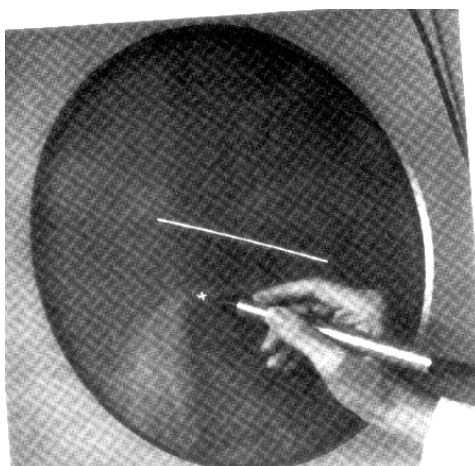

Manutenção e Modificação da Figura

Comportamento do Fósforo

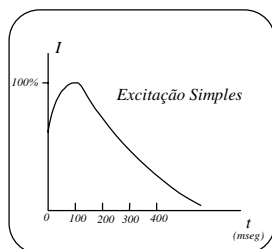

Solução encontrada

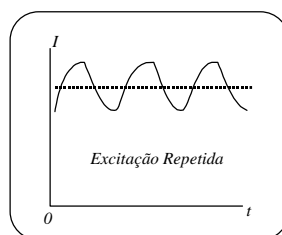

Histórico (1960...1985)

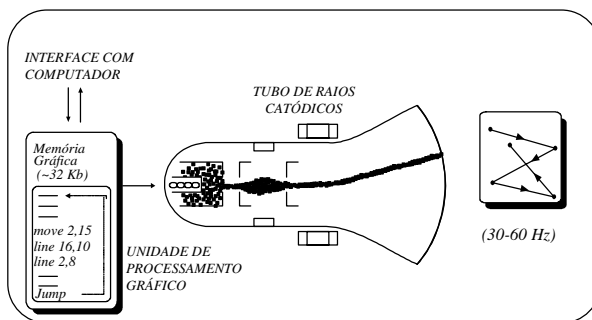

Disp. Vetoriais de Retraçamento

Histórico (1970 - 1985)

Tektronix 4010

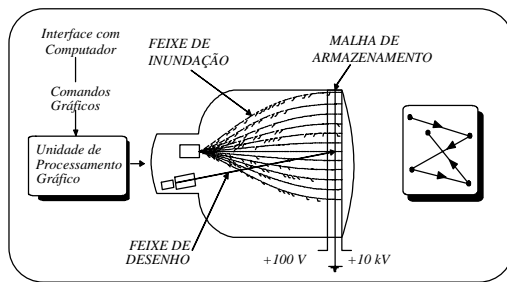

Disp. Vetoriais de Armazenamento

Problemas dos Modelos Vetoriais: ambiguidade

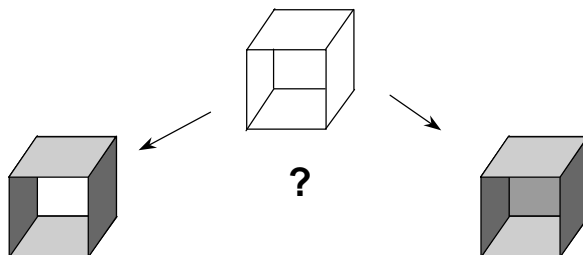
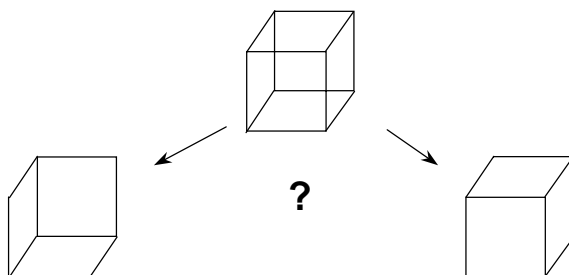

Dispositivos Matriciais (1980 ...)

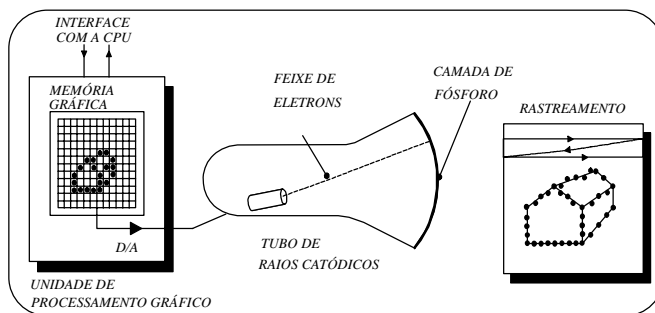

*Monocromáticos com dois níveis
(1 bit/pixel)*

CGAHI - 640x200
Hercules - 720x348

Dispositivos Matriciais (Vários “planos” de bits com tabela de tons)

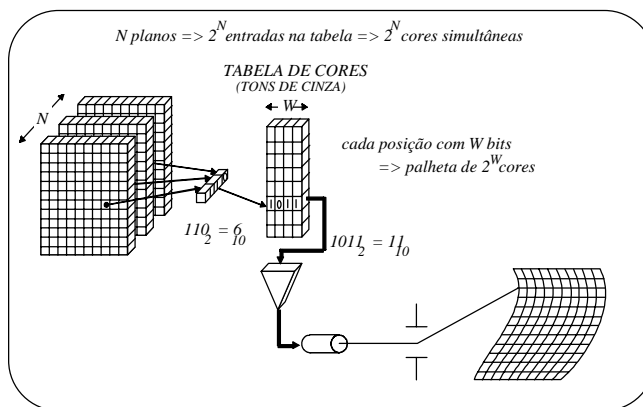

Tons de Cinza

Dispositivos Matriciais (Coloridos)

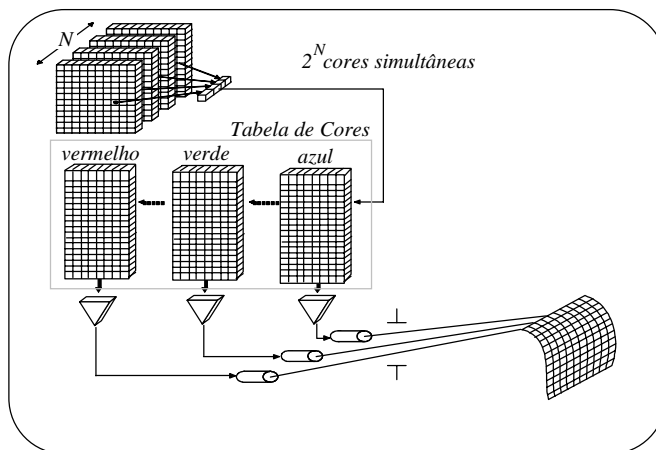

Monitores Coloridos - (Look-up Table)

EGA - 640x480 / 16 cores
VGA - 640x480 / 16 cores palheta de 64

Pixel Colorido

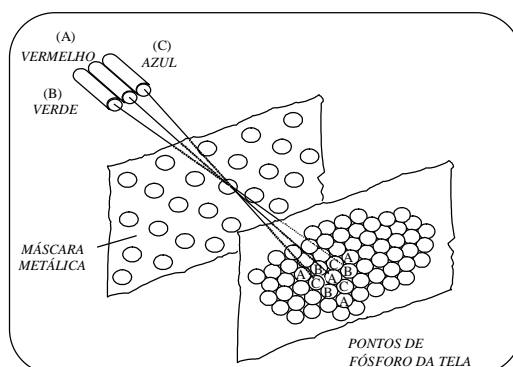

Codificação de Cor (índices de uma tabela)

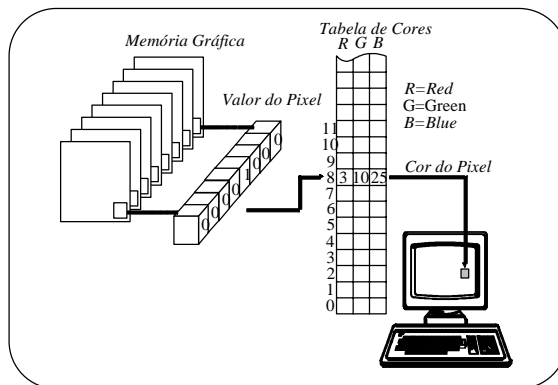

Codificação de Cor (planos de *bits* para cada cor)

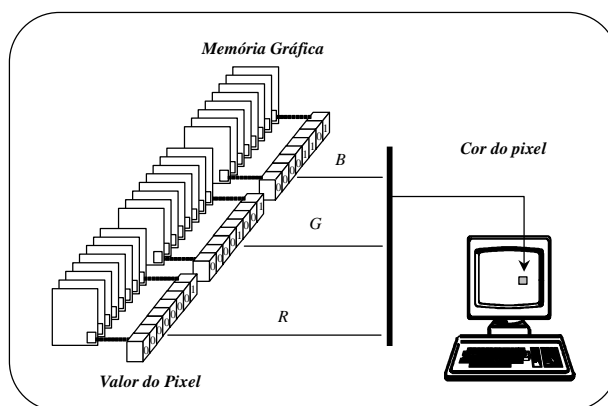

"True Color" - 1 byte p/ cada cor